

foundation guide

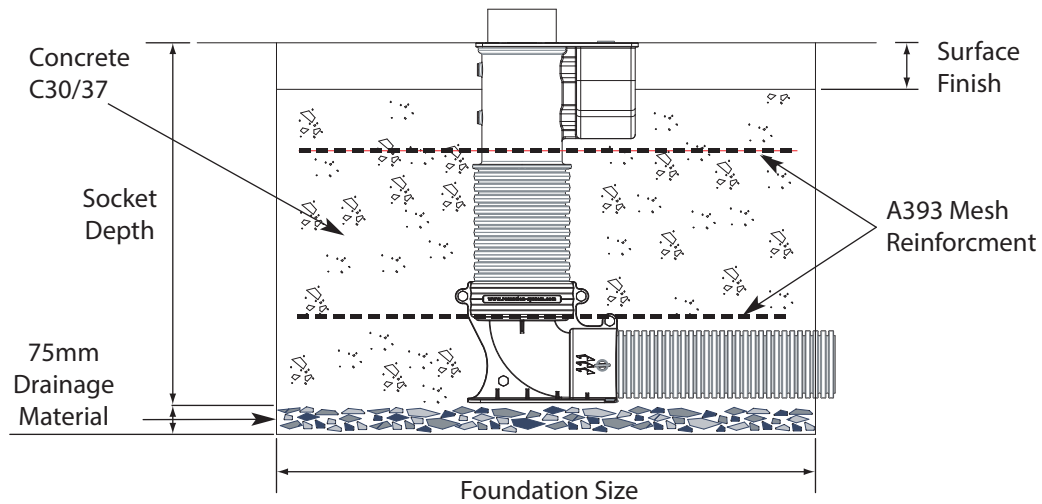

Foundation sizes shown here are based on loadings calculated using EN40-3-1:2000 for minimum post loadings and are guidelines only. For more detailed foundation sizing on specific site conditions contact your supplier.

All dimensions in Red require two layers of A393 mesh reinforcement.

rs socket depth		300	450	600	750	900	1200
rs socket size	post height	foundation size (mm)					
RS48 - RS60	4m	750x750	650x650	610x610	-	-	-
RS76	4m	750x750	650x650	610x610	-	-	-
RS89	6m	1050x1050	910x910	850x850	810x810	790x790	-
RS115	6m	1130x1130	990x990	920x920	880x880	850x850	-
RS140	8m	1480x1480	1300x1300	1200x1200	1140x1140	1110x1110	-
RS145	8m	1500x1500	1310x1310	1220x1220	1160x1160	1120x1120	-
RS168	10m	1850x1850	1610x1610	1490x1490	1410x1410	1370x1370	-
RS177	10m	1880x1880	1640x1640	1510x1510	1440x1440	1390x1390	-
RSe193	12m	2200x2200	1920x1920	1770x1770	1680x1680	1620x1620	1560x1560
RSe200	12m	2220x2220	1940x1940	1790x1790	1690x1690	1630x1630	1570x1570
RS219	12m	2290x2290	2000x2000	1840x1840	1740x1740	1680x1680	1620x1620



RS Installation Instructions

RETENTION SYSTEM™ INSTALLATION OF RS RETENTION SOCKETS

IMPORTANT READ THIS

1 Excavate as per table on page 4. Allow 75mm for Drainage Material below foundation.

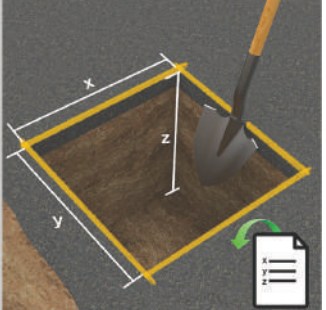

2 Insert socket, orientate head and base to suit. Set finished level with string line.

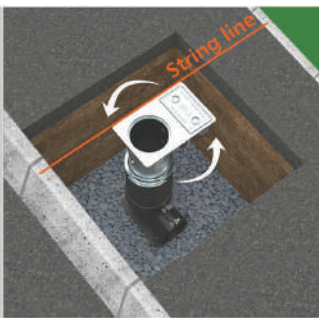

3 If required, connect ducting and insert draw cord.

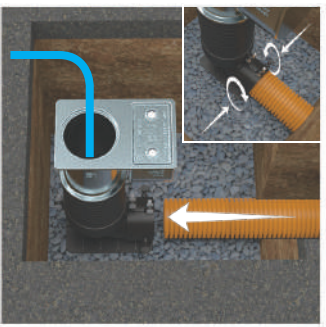

4 Insert and tighten levelling pole with bolts in the sidechamber of socket.

(DO NOT INSTALL WITHOUT A LEVELLING POLE)

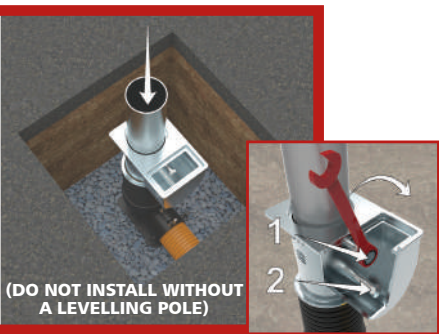

5 Surround with C30/37 minimum strength concrete. Vibrate to remove air.

A = 100mm MAX

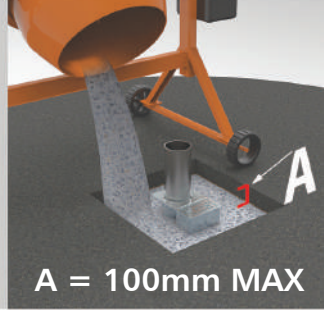

6 Using levelling pole, check vertical alignment.

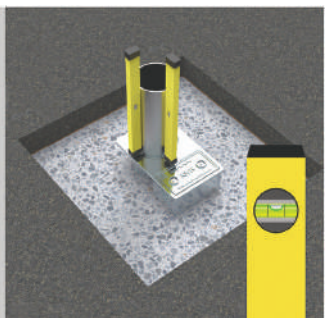

7 Remove levelling pole once concrete is set.

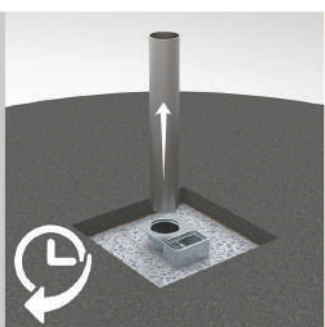

8 Replace pedestrian and side access covers. Re-instate finished surfacing.

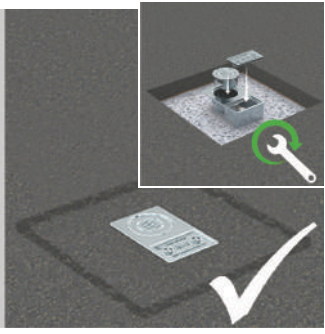
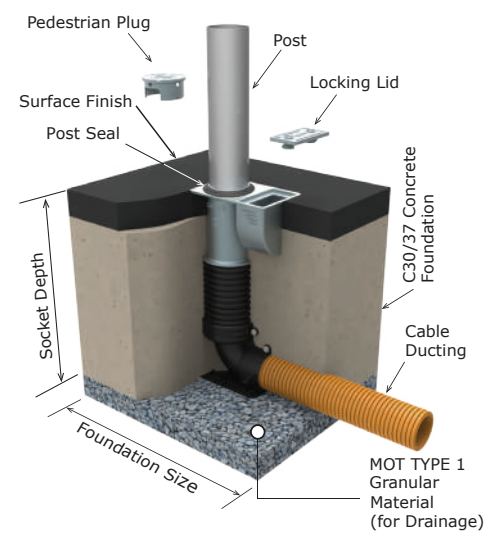
- ### INSTALLING A POST
- 1 Ensure POST SEAL is on the pole before inserting it into the socket.
 - 2 When post is installed in place, tighten the locking bolts firmly.
 - 3 Store the pedestrian plug in the side chamber and lock the lid.

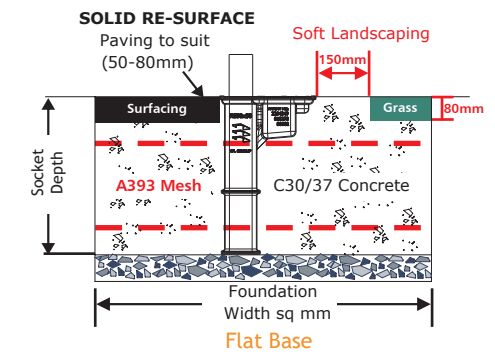

- ### REMOVING A POST
- 1 Once the fixing bolts are released the damaged post can be worked, rotated or levered to remove.
 - 2 Remember to retain the rubber post seal by storing it in the side chamber. Fit the pedestrian plug until the new post is ready to be installed.

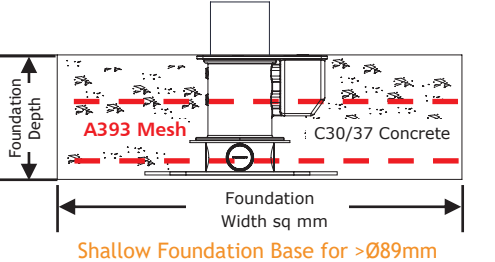

- ### INSTALLING ON A SLOPE
- 1 For minor slopes, the finish surface can be graded to the edge of the socket.
 - 2 For more severe slopes, a tapered top wedge can be installed and the finished surface graded to this. Contact your RS supplier for more information.
 - 3 Continue the RS socket installation in the stated method.

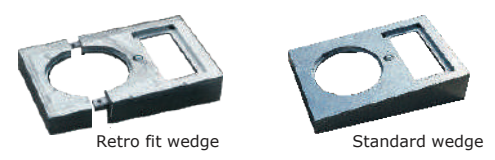
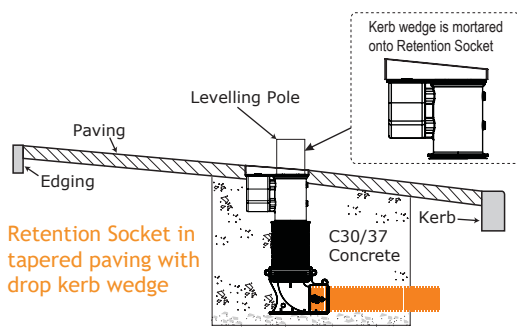

1. THE LEVELLING POLE SHOULD BE OF SAME SIZE AND SHAPE OF THE POLE TO BE INSTALLED
 2. FOR THE INSTALLATION OF NON CYLINDRICAL POLES, CONTACT YOUR LOCAL 'RETENTION SYSTEM' SUPPLIER